



**IDEAL INDUSTRIES INC.**

## **The Basics of Digital Multimeters**

**A guide to help you understand the basic  
Features and Functions of a Digital Multimeter.**



Author: Patrick C Elliott  
Field Sales Engineer  
IDEAL Industries, Inc

January 2010, Version 1

## The Basics of Electricity

To better understand digital multimeters, it's helpful to become clear on the basics of electricity. After all, DMMs always measure some aspect of electricity.

Electricity passing through a conductor is similar to water flowing through a pipe. Every pipe has force that creates a certain pressure, causing water to flow. In the case of electricity, that force might be a generator, battery, solar panel or some other power supply. The pressure created by that power supply is called voltage.

Voltage is the pressure applied to the circuit.

Current is the Flow of the electricity in the conductor.

Resistance is any restriction to the flow of the current in a conductor.

Voltage, current and resistance are the three most fundamental components of electricity. Voltage is measured in volts, current in amps and resistance in ohms.



*The three components in an electrical system are electrical pressure, or voltage (measured in volts), the amount of electricity flowing, or current (measured in amps), and impedances within the system, or resistance (measured in Ohms)*

## Voltage, Current and Resistance

Voltage is the pressure that is applied to a conductor. There are two common types of power sources, Alternating Current (AC) and Direct Current (DC). Alternating Voltage is the most common form of electricity. It is the power supplied by the utility or generators, which flows through our electrical circuits. The symbol for AC voltage is  $V\sim$ .

### Alternating Voltage

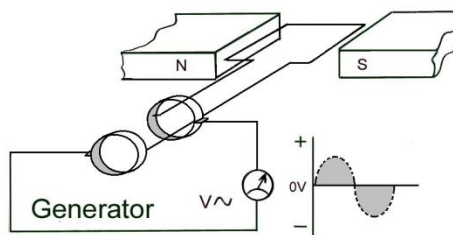

*A generator creates electricity from two opposite magnetic fields, as the wire turns between these two fields, electrons are pulled first in a positive, then in a negative direction*



DC Voltage is a constant level of stored energy. It is stored in batteries or converted from alternating voltage through the use of electronic rectifiers. Electronic products like TVs, VCRs and computer equipment run on DC power.

The symbol for DC voltage is  $V---$ .

## Direct Voltage

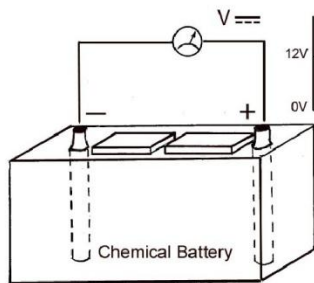

Unlike alternating voltage, direct voltage is a steady flow of positive energy. It is commonly stored in batteries for use in electronic equipment.



Current is the flow of electricity through a conductor. As with voltage, there are two types of current, AC and DC. The symbol for current is the letter **A**.

The third component is resistance, measured in Ohms. Resistance in the circuit impedes the flow of current through a conductor. The symbol for resistance is the Greek Omega,  $\Omega$ , sometimes referred to as the horseshoe.

## Ohm's Law

Together, voltage, current and resistance comprise Ohm's Law. Ohm's Law is an important equation for electricians. By using a DMM, they can establish values for the three variables which help in diagnosing electrical problems.

Ohm's Law can be expressed in equation form in this way:

$$\mathbf{V = A \times \Omega}$$

**Voltage = Current  $\times$  Resistance**

Ohm's Law is expressed in an equation:  $V=A \times \Omega$

**Tech Note:** Voltage determines the flow of current; the greater the voltage, the greater the current. If resistance is increased, the current will decrease. Lower the resistance, and current will increase. The relationship of these three elements of Ohm's Law; Volts, Ohms and Amperes, must mathematically balance.

Let's take an example; say we have a 120 Volt outlet and a hair dryer. If the hair dryer is set on low, it would draw 7 amps. The load resistance is around 17  $\Omega$ , but if we change the setting to high, the current draw would increase to 12 amps, and the load resistance will decrease to 10  $\Omega$ .

$$\begin{array}{l} \mathbf{V = A \times \Omega} \\ \mathbf{120 = 7 \downarrow \times 17 \uparrow} \\ \mathbf{120 = 12 \uparrow \times 10 \downarrow} \end{array}$$

If Ohms ( $\Omega$ ) increase, current (A) decreases, and if Current (A) increases, Ohms ( $\Omega$ ) decreases

For useful formulas See Appendix A

## Electrical Circuits

In an Electrical system, there are two ways that loads are connected in a circuit, in Series or in Parallel.

**In a Series Circuit**, each device is connected together in a line. Current flows through each device connected to the circuit. If you were to increase the resistor in the *Series Circuit* shown below, the light would dim. You have restricted the flow or available current to the light.

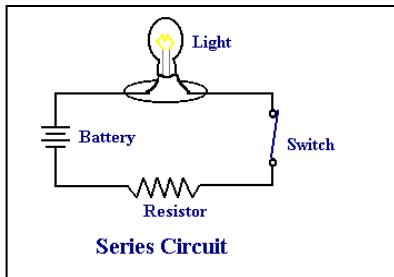

*In a series circuit, loads within the circuit have an impact on the flow of electricity to the other loads.*

**In Parallel Circuit**, the same amount of voltage is applied to each device. Current can flow freely through each device without affecting another. Our homes are wired in Parallel for this reason.

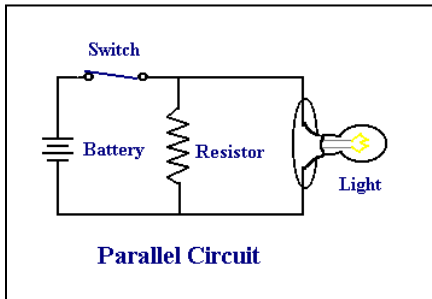

*In a parallel circuit, loads within the circuit will not impact the flow of electricity to the other loads.*

When making measurements with a digital multimeter, it is important to remember that Voltage measurements are made with the test leads connected in Parallel, and Current measurements are made with the test leads connected in Series.

**Tech Note:** *The number one mistake made when using modern multimeters is to try and measure voltage with the test leads in the current input jacks. The input impedance of the current inputs jacks is in the range of 0.1 ohm to around 8 ohms, depending on the manufacturer. This low impedance is like a short circuit when making a voltage measurement. Because of this low resistance and possible short circuit condition most multimeters current input jacks are fused for protection. Well constructed meters will use a high energy fuse for this protection but you will blow the fuse if you test in this manner.*

## Types of Multimeters

There are two common types of Multimeters, Analog and Digital. Digital Multimeters (DMMs) are the most common. They use a liquid crystal display (LCD) technology to give more accurate readings. Other advantages include higher input impedances, which will not load down sensitive circuits, and input protection.

**Analog meters** use a needle movement and calibrated scale to indicate values. These were popular for years, but recently their numbers have declined. Every voltmeter has an internal resistance or impedance. The input impedance of an analog meter is expressed in “Ohms per Volt”

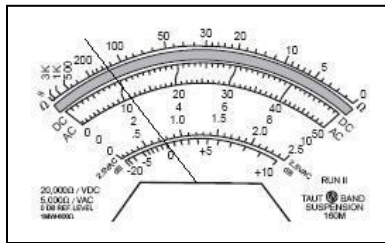

The input impedance of an analog meter is expressed in “Ohms per Volt” In this example the impedance for AC volts is 5000 ohms per volt. If I want to measure 120Vac the input resistance would be 5000 x 120 or 600,000 ohms.

**Tech note: Analog Meters** The internal impedance of the meter is in parallel to the measured circuit. You want this impedance to have as little effect on the measurement as possible so the higher the impedance the better. For most electrical measurements this effect is minimal, but for sensitive electronics of today the effect of the added resistance could be significant. This is just one of the disadvantages of an Analog meter. There are however a few useful applications for analog meters, so they aren't going away tomorrow.

**The Digital Multimeter (DMMs)** feature a digital or liquid crystal display (LCD). Measurement readings are displayed as numerical values on the LCD Display. The display also alerts you to any pertinent symbols and warnings.

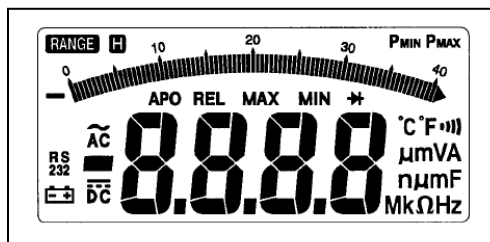

**Tech Note: Digital Multimeters and ClampMeters** use different techniques internally, to measure AC, DC voltage, Resistance and Amperes. An advantage of a digital multimeter is their accuracy and input protection. Their input resistance or impedance is very high, in the range of 1,000,000 to 10,000,000 ohms, so there is little effect on the measurement. On good quality meters, their inputs are also protected from faults and misuse. Test instruments today devote a good deal of architecture to overload protection. Most digital

meters meet some safety standard such as UL601010 or IEC (International Electro-technical Commission).

### DMMs at a Glance

The port panel is where you plug in your test leads. The diagram below explains where the test leads go for specific tests.

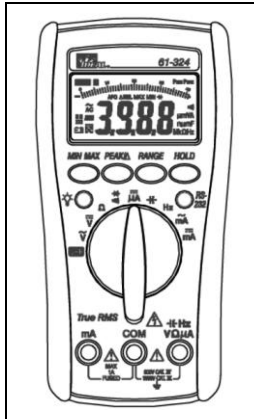

*Digital multimeters are more commonly used because of a few key features, including higher accuracies, higher input impedances and input protection.*

### Multimeter Safety

When making a meter selection look for a tester that is independently certified to some safety standard, UL, IEC, CSA.

Pay close attention to how and where you are using the equipment. Never use equipment that is outside of its manufacturer specified measurement range, or outside of its category rating.

Over Voltage Category	Description of Category
CAT IV	Primary supply, Overhead or underground utility service.
CAT III	Distribution level mains, fixed installation
CAT II	Local level mains, appliances, portable equipment.
CAT I:	Signal level, special equipment or parts of equipment, telecommunication, and electronics.

**Tech Note: Multimeter Safety.** *The major issue addressed by the UL601010 standard was to look at fault potential to available energy and define limited by category to each. The most common fault was high voltage transients on high energy circuits. If a transient were to cause a fault within an instrument with high energy present, it could result in a cascading failure of meter, equipment, and possibly personal injury. The easiest way to understand the different category ratings of the IEC standard is to think of the potential Short Circuit energy. The higher available short circuit energy, the higher the category.*

For additional information on Meter Safety refer to the IDEAL whitepaper on METER SAFETY

### The Dial

#### Setting the Function

The dial of the DMM allows you to choose the function you're interested in measuring. Whether you intend to measure one of the three elements of Ohm's Law, or a more advanced function like frequency or capacitance, you must first set the dial to the appropriate function.

#### Setting the Range

The dial also plays another essential role in measuring electricity – that of determining the range of measurement. The range you select on the dial determines the placement of the decimal point as it appears on the LCD. In turn, the position of the decimal point determines how refined, or precise, your reading is. This is called resolution.

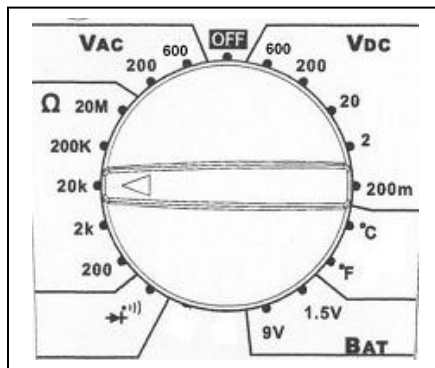

*On a manual ranging meter, the function and range must be selected*

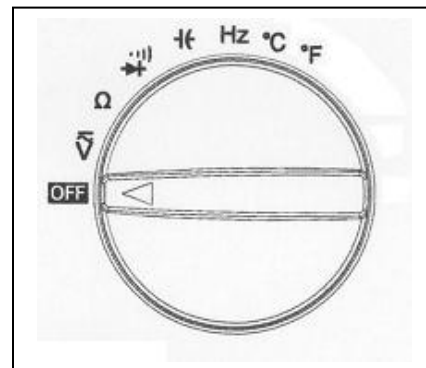

*Auto ranging meters will automatically choose the measurement range*

Symbols	Measurement Functions	Descriptions
$V \sim$	AC Voltage	Measures amount of AC Electrical Pressure
$V \text{---}$	DC Voltage	Measures amount of DC Electrical Pressure
mV	Milli Volts	.00V or 1/1000V
A	Amperes	Measures amount of electron flow
mA	Milli Amperes	.001 or 1/1000A
$\Omega$	Ohms	Measurement of resistance to the flow of electron
$\rightarrow $	Diode	Device used to control direction of electron flow
$\bullet \rightarrow  $	Audible Continuity	Audible indication of continuity for low resistance
$\text{---} $	Capacitance	Device used to store electrical potential

For A complete listing See Appendix B

## Auto vs. Manual Ranging

**Tech note: Manual ranging multimeters** force us to think about the measurement before we select the range of the meter. As an example, if I want to measure 120V AC on a manual ranging meter I would turn the Dial or switch to the VAC section and select the 200V Range. This gives you ample measurement range and the maximum resolution for the measurement. If the voltage is unknown, start with the maximum or highest range and step down to achieve the maximum resolution on the display. Note that OL or overload means that you need to select a higher range and this should not damage the meter.

**Tech Note: Auto ranging multimeters**, only the measurement function needs to be selected. The multimeters circuitry will “automatically” select the best range for the measurement. There are two things to remember about an auto ranging meter. One thing is that the timing for the meter to achieve and settle on a range can take a few seconds. The other is the symbols and numerical expression used on the display. If a user fails to pay close attention to what the display is telling them, an error can occur with the interpretation of the displayed value. As an example, 240mV could be interpreted as 240V if the user doesn’t pay close attention to the little “m” in the “mV” icon on the display.

## Understanding Count, Resolution and Accuracy

The count is the maximum number of digits that can be shown on the display. In most cases this value is one less that the Count of the display. For example if you have a 2000 count unit, the maximum reading per range is 1999 or one less that 2000.

To get a better understanding of resolution, let’s take an example. If you are using a manual ranging unit that is set on 20V and you’re measuring an application that puts out more than 20V, the display will read “OL”, or overload. You must reset the dial to a higher range and take a new reading. The most refined reading, therefore, uses the range that provides the best resolution without overloading. Select the range just higher than the expected reading.

Range Setting	Maximum Range and Resolution
2V	1.999V
20V	19.99V
200V	199.9V
1000V	1000V

## Meter Accuracy:

Most meter’s accuracy are expressed as a +/- percentage of input + a +/- number of counts, expressed as +/-{ X% + No. of counts}. For example, the Ideal 61-342 is a 4000 count display with a basic DC Voltage accuracy of +/-{0.5% + 5} The +5 is called the



count or floor and refers to the least significant digit of the display in reference to range and resolution.

If we want to determine the maximum error of the meter that is measuring a source of 12V, first determine the percentage error and add the count or floor.

The % accuracy for a 12V source would be  $12 \times 0.005 = 0.06$

To determine the count, we must determine the meter's range and resolution. If the display is a 4000 count display, we need to determine the best range and resolution. For 12 V this would be the 40V range. The display maximum resolution is 39.99 and the least significant digit would be 0.01 with a total count of 0.05

The accuracy of the meter is  $\pm (0.06 + 0.05)$  which is  $\pm 0.11$ , so the Low limit is 11.89 and the High limit would be 12.11

**Tech Note: Display Counts & Resolution**

The display count is the maximum digital resolution of the multimeter. A 2000 count display, has a maximum reading of 1999, one less than the display count. A 4000-count display has a maximum reading of 3999. These two displays are the most common, 5000, 20,000 and even 50,000 count displays are also available. The display count determines maximum range and resolution.

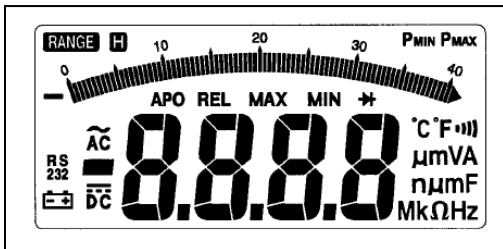

A 2000 count unit is often called a 3-½ digit display. The 3 refers to the number of full digits, and the ½ refers to the capabilities of the most significant digit (furthest to the left) which can be either a 1 or 0. Most meters today are 4000 count units. This means that the most significant would be 0 to 3 or one less than the count of the analog to Digital Converter.

The display count is important in determining the maximum resolution (number of digits after the decimal point) of the reading. As an example, let's look at the difference when measuring a 240-volt supply with a 2000 count and 4000-count multimeter and what range you would set the meter to.

The 2000 count display would be in the 600V range and display 280 volts. The maximum resolution is 1 volt. The 4000-count multimeter would be in the 400V range and have a maximum resolution of .1V. The unit would display the measurement as 280.0 volts.

Range	Reading	Resolution
600	600	1V
200	199.9	.1V
20	19.99	.01V
2	1.999	.001V
200mV	199.9	0.1mV

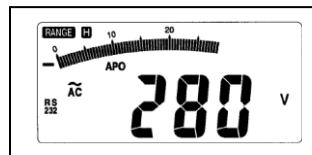

The 2000 count unit would need to be set on the 600 volt range to measure 280V. On the 600V range the maximum resolution would be 1 Volt.

Range	Reading	Resolution
600	600	1V
400	399.9	.1V
40	39.99	.01V
4	3.999	.001V
400mV	399.9	0.1mV

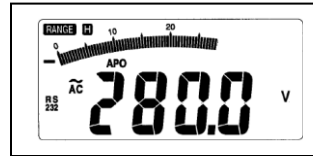

The 4000 count unit would be set on the 400V range to measure 280V, and have a maximum resolution of .1V. In this case the 4000 count unit would give you the best resolution.

It is important that we understand our numerical expressions to properly setup or read the display of a Multimeter. In this example we have an auto ranging meter, measuring a 2,800,000 ohm resistor. The display reads 2.800 M Ω. M is the Symbol for Mega or one million ohms.

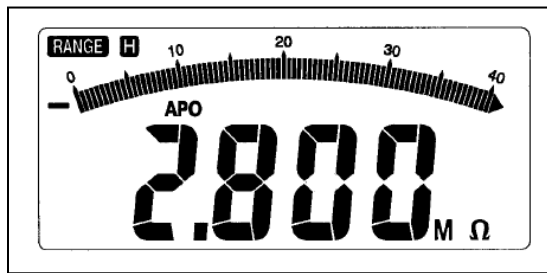

In this example the meter reading is 2.800 M Ω, expressed as 2.8 Meg Ohms or 2,800,000 ohms.

### Numerical Display notation

Terms	Numerical Values	Symbol	Expression
Giga	1,000,000,000	G	$\times 10^9$
Mega	1,000,000	M	$\times 10^6$
Kilo	1,000	K	$\times 10^3$
Milli	.001	m	$\times 10^{-3}$
Micro	.000001	μ	$\times 10^{-6}$
Nano	.000000001	n	$\times 10^{-9}$

### Port Panel

The port panel is where you plug in your test leads. The diagram below explains where the test leads go for specific tests.

## Instrument Input Jacks or Ports

The input jacks or ports of your meter are the working ends of the instrument. Use care when connecting leads to your instrument. Pay close attention and be sure to connect the leads into the correct port that is marked for the measurement selected on the dial.

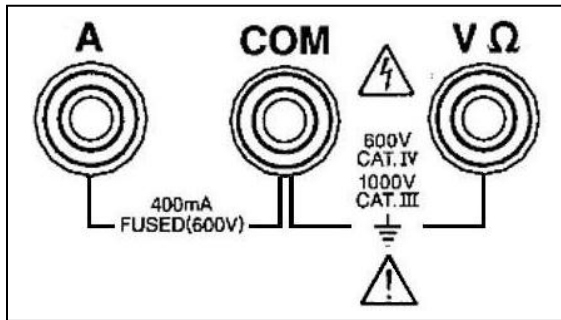

**DC Voltage Measurements:** To measure DC voltage, we place the Red lead into the **V Ω** port and black lead into the **COM** port. Turn the dial or switch to  $V_{DC}$  or  $V \text{ --- }$ . If it is a manual ranging meter set it for the proper range. As in the example below, we want to measure a 9V battery so the best range would be the 20 V range. If you have an auto-ranging meter you only need to set the function on the dial to  $V_{DC}$  or  $V \text{ --- }$ .

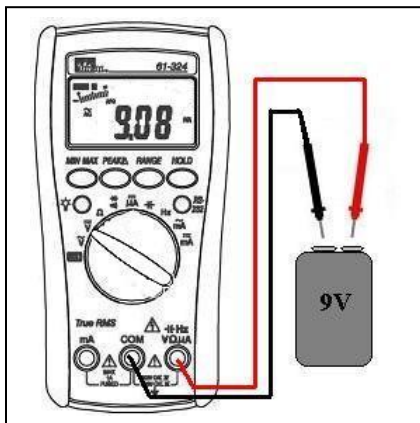

*Most Digital Multimeters are auto-polarity sensing devices. This means that we don't have to worry about having the Red lead on the hot or positive and the Black Lead on the Neutral or negative.*

*If you do not pay close attention to polarity when using an Analog meter the meter movement or meter could be damaged*

**AC Voltage Measurement:** To measure AC voltage, we place the Red lead into the **V Ω** port and black lead into the **COM** port. Turn the dial or switch to  $V_{AC}$  or  $V \sim$ . If it is a manual ranging meter set it for the proper range. As an example the meter would be set to the 200 V range to measure a 120V outlet. . If you have an auto-ranging meter you only need to set function to  $V_{AC}$  or  $V \sim$ .

Remember that it is always a good practice to connect the black lead first then the red.

### **Tech Note: Voltage Measurements**

Voltage measurements are perhaps the most common function used on a multimeter. Voltage is measured between two points so we must make sure that we have solid contact at each point. The proper way to connect a meter is to connect the low or ground (black lead) first and the High (Red lead) next. We remove the leads in reverse order, Red first and then Black.

Whenever making live voltage measurements use the Three Point method. Measure a known live circuit or source first, then the unknown circuit, then back to the known circuit.

### **Average Responding vs. True RMS**

The RMS or Root Mean Square value of an AC measurement is the “Effective Value” or “Equivalent Value” of the waveform to do work in relationship to DC. Test Equipment use two methods to measure an AC waveform. One is Average responding RMS calibrated and the other is True RMS. Both are designed for periodic type perfectly sinusoidal waveforms and most are AC coupled, meaning that it blocks any DC bias that may effect the measurement.

**Average Responding voltmeters** use a simple circuit to provide a general-purpose voltmeter a low cost method to calculate the RMS value of a sinusoidal waveform. The True effective value can be obtained as long as the AC waveform is a periodic sinusoidal waveform.

When measuring complex waveforms with harmonics, such as square waves or AC signals which have been rectified or electronically controlled in some way by devices like diodes, SCR's or triac's, the True RMS or “effective heating value” cannot be accurately measured using an Average responding meter. You must use a True RMS meter to make an accurate measurement.

**True-RMS voltmeters** use an integrated circuit that computes the true root-mean-square value of a complex waveform. Most are AC coupled, but in some higher end meters “AC + DC” coupling is available which gives you the “effective heating value” of both the AC and DC component of the waveform.

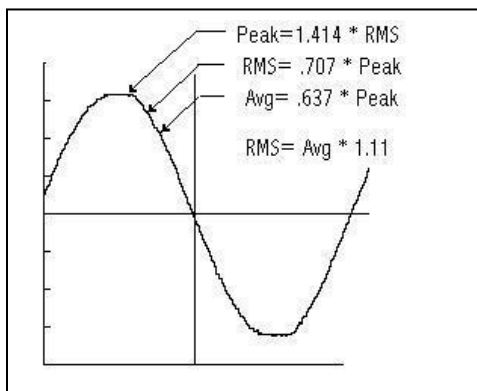

The Root Mean Square value is a measurement of the “Effective Value” of the waveform or the ability to do work.

Average responding meters measure the average value of a pure sine waveform and calculate the RMS value

Ave of .637 x 1.11 = RMS of .707

*In commercial and industrial environments, loads like electronic lighting, computers, variable speed drives and other electronic equipment draw current in short pulses. This type of load is called non-linear because it doesn't draw its current linearly with the load voltage. The non-sinusoidal or distorted waveforms create harmonics. This distortion of the waveform can cause an average responding meter to be as much as 10% to 40% inaccurate. A DMM that is True RMS responding is more accurate in these situations because it calculates the True Root Mean Square (RMS) value of the distorted waveform. NEC and others now recommended the uses of True RMS meters on today's electrical power systems.*

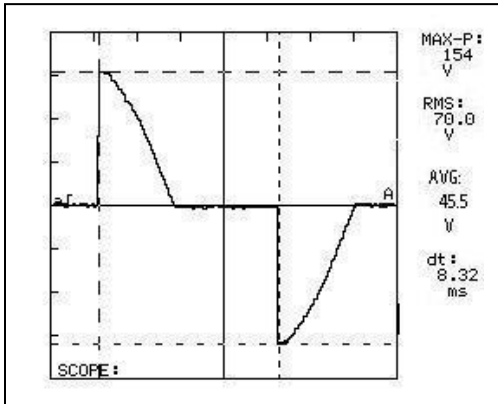

*In this example of a common light dimmer the power is turned down to about 50% output. The Average value measured was 45.5 volts AC. The True RMS value was 70 volts AC. The error between the average reading and the true effective value was 35%.*

### **Current Measurements**

Current is the electron flow that causes electrical equipment to operate. When the equipment is turned on, it is considered to be a “load” on the circuit. A load is any electrical component, such as a lamp, stereo, motor or heating element, that draws current. Current is measured in amperes, or amps.

Each load has a rated current limit that should not be exceeded. If a load pulls too much current, excessive heat is produced that may cause insulation damage, component failure and possible fire hazards. If the load is under its rated current limit, it may perform poorly.

Testing current may be done in several ways, but the most common method, and the most simple, is with a clamp meter.

This indirect measurement is inherently safer than using a multimeter in series with the circuit. When making a measurement with a Clamp meter, clamp to either the Hot or Neutral conductor but not both.

To measure using a meter we must open the circuit and make the measurement in Series with the load. This is the most potentially hazardous measurement made with a multimeter because the meter now is a part of the circuit.

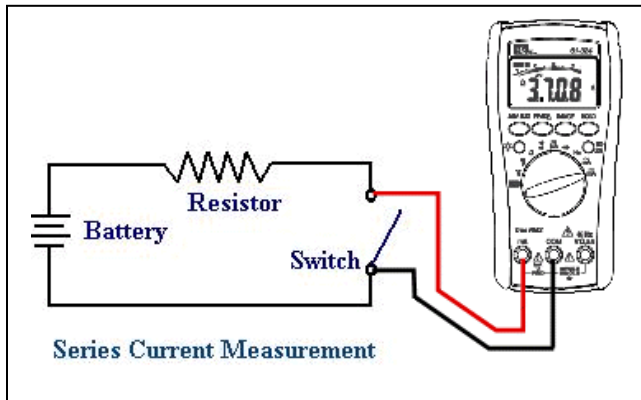

To measure current with a multimeter, turn the power off at the breaker as close to the source as possible. Break the circuit, connect the multimeter in series with the circuit, and reestablish power.

**Tech Notes:** Good multimeters are now protected by a high-energy fuse. High energy fusing is used to protect the meter and the user, but let's not forget "Murphy's Law". The most common mistake is to accidentally have the test leads in the current input jacks and make a voltage or parallel measurement. Meters without fuse protection on the current inputs should not be used on high energy electrical circuits.

From a practical standpoint, only small currents are measured with a multimeter. Most multimeters have a maximum current capability of 10 amperes. It is also not practical to shut down power and break the circuit to take a measurement. The most common application for direct current measurements with a multimeter is small DC currents, like 4-20 mA control loops found in most process control systems.

### Using a Clamp or Current Transformer.

**Tech Note:** When using a Clamp-meter, or a Multimeter with a clamp adapter. A Clamp-or Current transformer (CT) measures the magnetic field around a conductor. The strength of the magnetic field is determined by the amount of current flowing through the conductor. This allows the clamp meter to measure the current flow indirectly. It is also important that the Clamp be around either to Hot or Neutral. Current flows through both wires but create magnetic fields in opposite directions. If you clamp around both wires the meter would read "0"

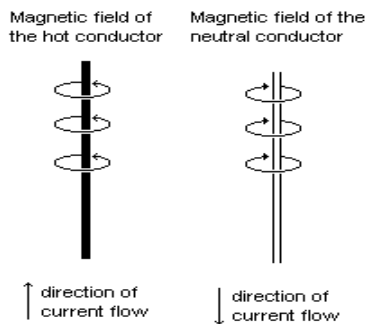

In a household power cord, current flows to the load through the hot conductor, and returns back through the neutral conductor. As the current flow is identical, the magnetic fields would be exactly the same strength, and cancel each other out, resulting in a measurement of 0.

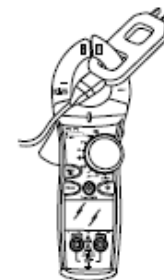

*'Clamp-meters also allow a much higher level of current measurements. While most multimeters have a maximum internal current measurement of 10 amps, clamp meters are available that measure 400, 600 or even as much as 2000 amps. Meters with Clamp adapters can be used to make high current, but Clamp-meters are much simpler to use.*

*DC current is measured through the use of a Hall Effect probe. A Hall Effect device is a semiconductor that when subjected to a magnetic field responds with a voltage output that is proportional to the field strength. Unlike standard Current Transformer Clamps, Hall Effect current probes are electronic and powered in some way.*

*Clamp adapters differ from Clamp-meters in that they are designed to convert the AC or DC current measurement to a smaller AC or DC signal. This small signal output is either a millivolt or milliamp output. Most Clamp adapters are marked for the user.*

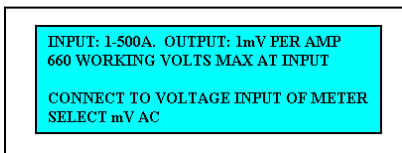

*This is an example of the label on the Ideal 61-334, 600 Amp Clamp adapter*

*Review the specifications of the adapter to determine the output signal and the ratio of the measurement to the output signal. This is typically 1mV/Amp or 1mA/Amp. Be sure to set the function switch on the meter to the appropriate measurement and place the test leads in the appropriate ports. Note that the reading will be displayed in millivolts or milliamps, not in Amps.*

## **Continuity Measurement**

Continuity is a quick check to see if a circuit is complete. Good fuses and closed switches have continuity. During a continuity measurement, the multimeter sends a small current potential through the circuit to measure the resistance of the circuit. The value for the maximum resistance can vary from meter to meter. Most will indicate continuity from 0 to 50 ohms. An audible alarm was added to aid in making fast go-no-go testing without taking your eyes off your work.

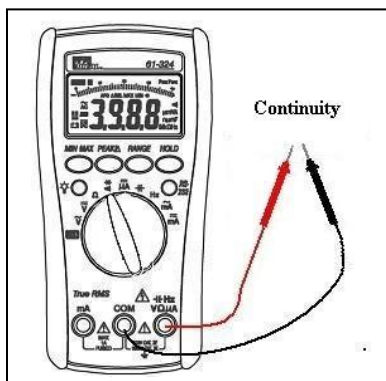

*Continuity is a great go no go test for switches and fuses. The audible beep gives you the freedom to keep your eyes on the work at hand.*

## Resistance Measurements

Resistance is measured in Ohms ( $\Omega$ ). When you first place the meter in the ( $\Omega$ ) function the meter will give a display of “OL” or “1 \_\_\_\_\_” indicating an infinite reading. It is important when measuring Resistance that the circuit be de-energized or turned off, or the circuit may damage the meter. Most meters have overload protection on all ranges to prevent this, but you should check the specifications of your digital multimeter to be sure.

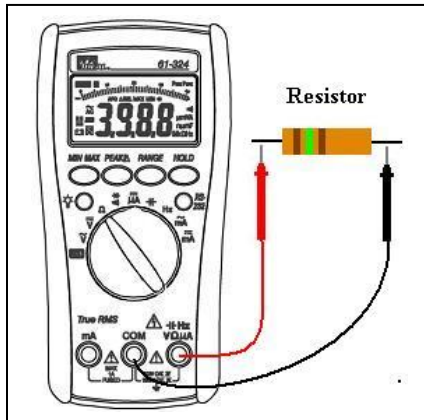

*For resistance measurements, place the test leads on each side of the resistor. Other components in parallel with the resistor being measured will have an effect on the measurement.*

## Diode Measurement

A diode is a semiconductor device which allows current to flow in only one direction. The standard Ohms function on a digital multimeter does not supply enough energy to test a diode. The diode function applies an appropriate amount of pressure, (or voltage potential), and measures the voltage drop across the diode.

To test a diode, first measure the forward bias of the diode. For most silicon diodes the voltage drop should measure around .5V +/- .2V.

Next, measure the reverse bias of the diode. You should see an “OL” or overload condition on the display.

Some meters display the voltage potential applied to the diode. In this case, in the reverse bias you would see the maximum voltage potential. This potential for most meters is around 3 volts.

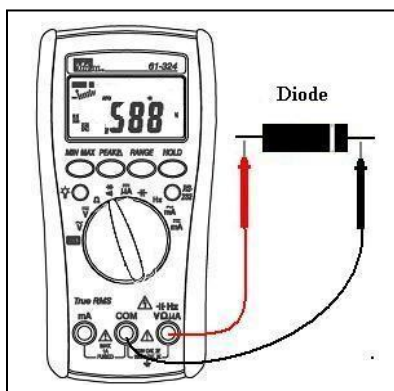

*Measuring both the forward and reverse bias of the diode ensures that current will flow in only one direction*

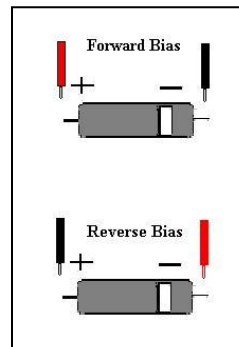



## Capacitance Measurement

A capacitor is a device that stores energy. It is widely used to give a boost of energy at start up when power is applied to lighting and motor systems. To test a capacitor, first remove power from the device. Remember that a capacitor stores energy so the next step is to discharge the device. Now you are ready to test. Never test without verifying that the energy has been discharged from the capacitor.

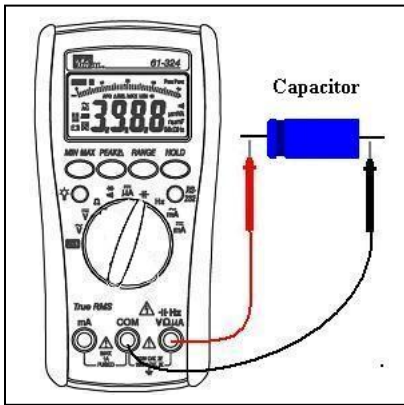

*Before making a measurement on a capacitor, make sure it is not holding a charge. Discharge the capacitor, using a 10,000 to 20,000 ohm 2 or 5 watt resistor.*

## Frequency Measurement

Frequency is measured in Hertz. This is the number of cycles per second of an Alternating waveform to complete one cycle or transition from 0 to max amplitude positive back to 0 to max amplitude negative then back to 0..

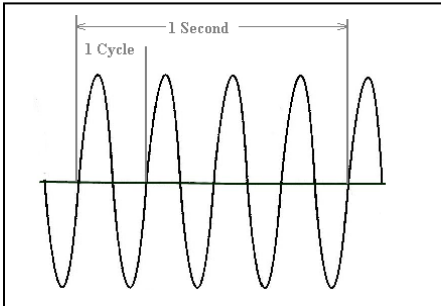

*Maintaining the right frequency is crucial for devices that rely on AC voltage and current. Otherwise poor performance and possible damage may result. In this example we have 4 cycles in one second so the frequency is 4Hz*

## ***Advanced Multimeter Functions***

Many features are available on today's advanced digital multimeters to make measuring electrical systems and components easier. There are two common methods used for these advanced features. Direct Key Selection or Menu Selection.

With the Direct Key function, "press and hold" for one second will activate the feature. "Press and hold" for two seconds will disable the function.

Try this with the RANGE key on an Auto-ranging multimeter. Pressing the key for one second turns manual ranging on and Auto-ranging off. Press again and you can manually step through the ranges. Press for two seconds and Auto-range is activated.

Menu units use a list of options in the display and "F" keys directly under the options. Pressing the "F" key below your selection will enable that function. Pressing the key again will disable it.

### **Data Hold, Auto Hold and Max Hold**

Data hold and auto hold locks the measurement on the display. These features are useful when making hard to get to measurements like in a panel. They allow you to focus your attention on the circuit under test instead of the multimeter display.

Data hold captures the display reading when pressed. Attach the common lead (black) to the desired measurement point with an alligator clip or other type of attachment device. Connect the red test lead to the circuit under test, press the data hold button then remove the test leads. Be sure to allow time for the reading to stabilize before pressing the data hold button to capture the measurement. Remove the leads and the display should hold the last stable reading.

Auto hold waits to capture the reading until after it stabilizes. Press the auto hold button and connect the test leads to the measurement circuit. After the reading stabilizes, the multimeter gives an audible signal to notify the user that the measurement has been captured. Remove the leads and the reading will stay for a few seconds before resetting to no reading.

**Max hold** displays the highest value that the meter has seen during the measurement. Connect the test leads to the measurement circuit and press the max hold button. The meter monitors the circuit and gives an audible indication when a new maximum reading has been obtained.

## Min/Max or Min/Max/Avg.

The min/max button captures the lowest, highest and average value that the meter has seen during the duration of the measurement. Digital multimeters with a dual display will show the real-time or instantaneous measurement on the main display, and show the min-max- or avg. value on the secondary display. Pressing the min/max button will step you through the minimum, maximum, and average readings recorded during the duration of the test. As with max hold, most meters will give an audible indication when a new minimum or maximum value has been captured. "Press and hold" for > 2 seconds will disable the min/max function.

A typical application would be monitoring a motor for over voltage and under voltage conditions. Remember to turn off the Auto Power Off function if you will be leaving the multimeter connected to the circuit for extended periods of time.

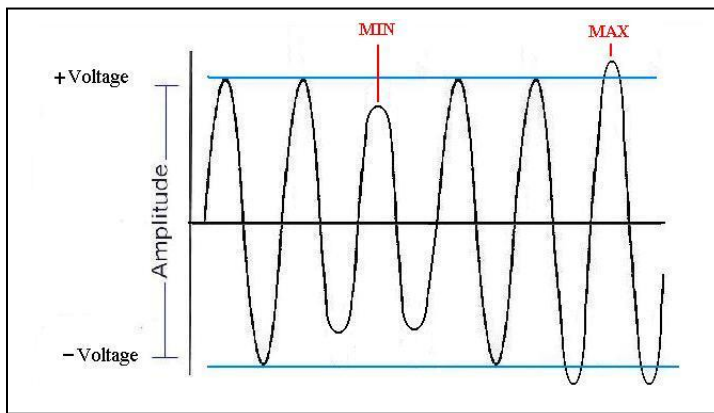

Some advanced multimeters will add an averaging function to this feature. It calculates the average reading over the duration of the test period.

## Relative Mode

Relative mode, usually displayed as  $\blacktriangle$ REL, stores the instantaneous measurement as a reference value, and sets the display to zero. Measurements are now shown as a differential to this reference value. To use this function, select the measurement, and attach the test leads to measurement circuit. Allow the reading to stabilize, and then press the  $\blacktriangle$ REL button.

The display should read zero. Take a new measurement. The difference from the new measurement and the original should be displayed.

This feature is often used when taking very low resistance measurements. The test leads of every multimeter have some resistance (0.1 to 0.2 Ohms). You can compensate by measuring the test leads using the relative mode feature. After the test lead resistance has

been set as the reference value, all new measurements will be the resistance of the circuit or component without the test lead resistance.

### Peak Hold and Peak Min/Max

Unlike True RMS measurements, which calculate the effective value of the voltage or current waveforms, Peak measurements capture the highest amplitude of the waveform.

Peak hold is often used to measure in-rush current caused by a motor start-up. Pressing the Peak Hold button on a clamp meter and clamping the jaws around one leg of the motor just prior to start-up will capture the highest peak, or in-rush current.

Another way to get this information is with a Peak min/max feature. This feature captures the highest and lowest amplitudes of the wave form.

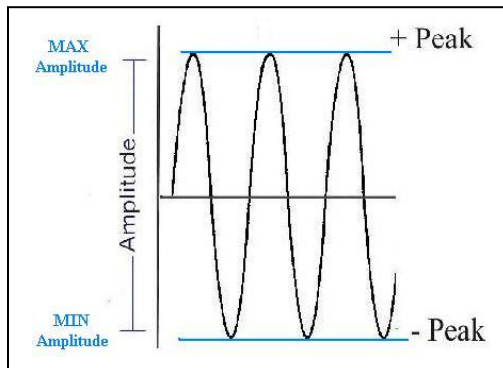

*A Peak min/max feature captures the highest and lowest points on the sine wave. When new minimum or maximum values are measured, the multimeter will capture new readings and notify the user with an audible beep.*

**Duty Factor or [% DF]** is a measurement of relative time between positive and negative parts of one cycle or pulse. How long on versus how long off.

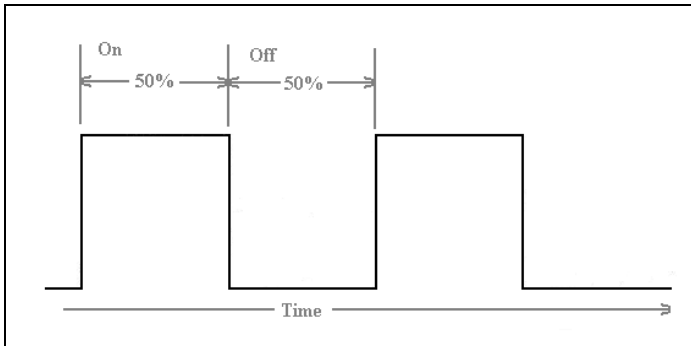

*In this TTL square wave the % of duty factor, time on versus time off, is equal or 50%*

**Appendix A**  
**Ohms Law Pie Chart**  
*Direct Current calculation*

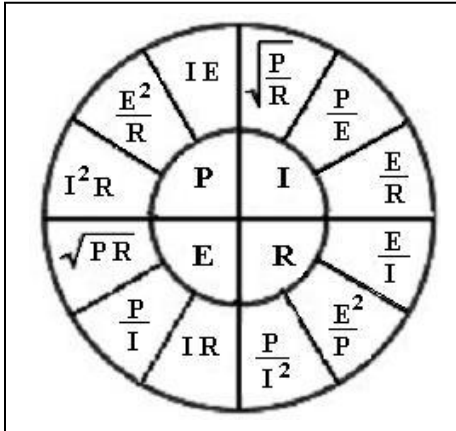

Symbolic	Term	Symbolic	Term
<b>V</b>	Voltage	<b>E</b>	Voltage
<b>W</b>	Watts	<b>P</b>	Watts
<b>Ω</b>	Ohms	<b>R</b>	Resistance
<b>A</b>	Amperes	<b>I</b>	Amperes
<b>C</b>	Capacitance		
<b>Hp</b>	Horsepower		
<b>EFF</b>	Efficiency		
<b>PF</b>	Power Factor		
<b>kW</b>	Kilowatts		
<b>kWh</b>	Kilowatt hour		Real Power
<b>VA</b>	Voltage Amperes		Apparent Power
<b>kVa</b>	Kilovolt-Amperes		

Direct Current Ohms Law.

Amperes= Watts / Voltage

Watts = Voltage x Amperes

Volts = Watts / Amperes

Horsepower= (Voltage x Amperes x Efficiency) / 746

Efficiency = (746 x Horsepower)/ (Voltage x Amperes)

## Ohms Law Pie Chart

*Alternating Current calculation*

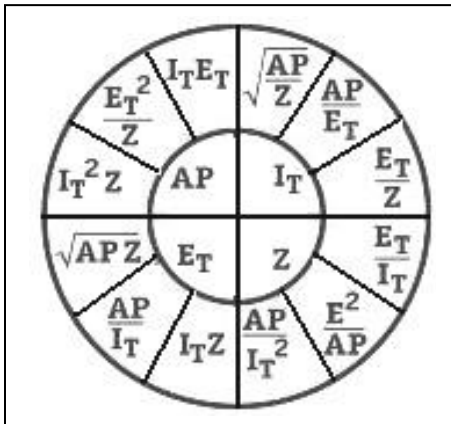

### AC Single Phase calculations



Amperes = Watts / (Voltage x Power Factor)	$A = W / (V \times PF)$
Watts = Voltage x Amperes x Power Factor	$W = V \times A \times PF$
Voltage = Watts / Amperes	$V = W / A$
Volt - Amp = Voltage x Amperes	$VA = V \times A$
Power Factor = Watts / Volt-Amp	$PF = W / VA$
HP = (V x A x Efficiency x PF) / 746	$HP = (V \times A \times EFF \times PF) / 746$
Efficiency = (746 x HP) / (V x A x PF)	$Eff = (746 \times HP) / (V \times A \times PF)$

### AC Three Phase Calculations

Amperes = Watts / (1.732x Volt x Power Factor)	$A = W / (1.732 \times V \times PF)$
Watts = 1.732 x Volts x Amperes x Power Factor	$W = 1.732 \times V \times A \times PF$
Voltage = Watts / Amperes	$V = W / A$
Volt - Amp = 1.732 Volts x Amperes	$VA = 1.732 \times V \times A$
Power Factor = Watts / (1.732 x Volt-Amp)	$PF = W / (1.732 \times VA)$
HP = (1.732 x V x A x Efficiency x PF) / 746	$HP = (1.732 \times V \times A \times EFF \times PF) / 746$
Efficiency = (746 x HP) / (1.732 x V x A x PF)	$Eff = (746 \times HP) / (1.732 \times V \times A \times PF)$

## Appendix B

### Measurement Functions

Symbols	Measurement Functions	Descriptions
$V_{AC}$	AC Voltage	Measures amount of AC Electrical Pressure
$V_{DC}$	DC Voltage	Measures amount of DC Electrical Pressure
mV	Milli Volts	.00V or 1/1000V
A	Amperes	Measures amount of electron flow
mA	Milli Amperes	.001 or 1/1000A
$\mu A$	Micro Amperes	.000001A or 1/1,000,000A
$\Omega$	Ohms	Measurement of resistance to the flow of electron
	Diode	Device used to control direction of electron flow
	Audible Continuity	Audible indication of continuity for low resistance
	Capacitance	Device used to store electrical potential
HZ	Hertz	Measurement of Frequency or number of cycles per/sec
$^{\circ}F$	Degrees Fahrenheit	Temperature measurement
$^{\circ}C$	Degrees Celsius	Temperature measurement

## Glossary

**A, ampere or amp** — The basic unit of electric current.

**AC, alternating current** — An electric signal in which the current and voltage vary in a repeating pattern over time; the most common type of voltage.

**analog meter** — A mechanical measuring device using a needle moving across a graduated scale or dial.

**APO- Auto-Power** — Off Automatically shuts down unit after a certain amount of time to preserve battery life. Most meters with APO may be disabled or set to a certain amount of time before shutting off.

**auto ranging** — A DMM that automatically selects the range with the best resolution and accuracy in response to the sensed values.

**calibration** — To adjust the meter measured value to a recognized artifact or standard.

**capacitance** — Ability of a component to hold an electrical charge, usually stated in microfarads.

**capacitor** — Electronic component which stores energy and then discharges it rapidly; blocks DC and allows AC to pass through.

**clamp-on** — DMM with jaws that allow it to fit around a conductor to measure AC or DC current without breaking the circuit.

**contact** — A connection between two conductors that allows a flow of current.

**continuity** — A continuous path for current flow in a closed circuit.

**current** — The flow of an electrical charge through a conductor; measured in amperes or amps.

**DC, direct current** — a direct, steady voltage; typically produced through electromagnetism, chemicals (batteries), light, heat or pressure.

**data hold** — Feature of a DMM that allows continued display of the last reading taken after probes have been removed.

**diode** — Electronic device in circuits that allows current to flow easily in only one direction and blocks flow in the opposite direction.

**DMM, digital multimeter** — An instrument that uses an LCD display typically capable of measuring voltage, current and resistance.

**F, farad** — The basic unit of capacitance.

**frequency** — The number of cycles per second that a wave form repeats; measured in hertz. (Line voltage in the U.S. is 60 Hz.)

**ground** — A large conducting body (earth) used as a common return for fault current in a circuit.

**H, hertz** — One cycle per second; the unit of frequency.

**harmonics** — A signal with a frequency which is an integer multiple of the fundamental frequency (60Hz); may damage or degrade the performance of electrical devices.

**harmonic distortion** — Diminishes power quality; caused by non-linear loads such as variable speed motor drives, electronic lighting ballasts and computers.

**impedance** — Total opposition to current flow; includes resistance, capacitance and reactance.

**load** — Any device which consumes power in a circuit.

**manual ranging** — DMM that requires the user to manually select the range, using the meter's dial.



**min/max** — Feature that allows a meter to capture and store the highest and lowest readings during a specific measurement.

**ohm** — The basic unit of resistance, specified as equal to that of a conductor in which one amp of current is produced by one volt of potential across its terminals.

**OL, overload** — Signal amplitudes or frequencies above the specified limits of the instrument; typically displayed as “OL” on the display of a DMM.

**peak hold** — Feature of DMM that allows retention of highest reading in a series of measurements.

**polarity** — The positive or negative direction of DC voltage or current.

**resolution** — Increments in value that can be displayed by a DMM; the greater the resolution the more precise the readout.

**resistance** — Opposition to current; measured in ohms.

**Sleep mode** — Automatically shuts down unit not in use to preserve battery life.

**short** — Any connection that has relatively low resistance or any resistance between two points below a preselected threshold. Typically, this is unintended.

**True RMS meter** — DMM that has the True RMS feature, allowing for accurate measurement of AC voltage in environments with harmonics (see harmonics).

**V, volt** — The unit of electrical pressure; one volt is the potential difference needed to cause one amp of current to pass through one Ohm of resistance.